

Experimental Investigation of a New Device in Suppressing Vortex-Induced Vibrations of a Circular Cylinder

Liming Lin, Xingfu Zhong, Yingxiang Wu

The Key Laboratory for Hydrodynamics and Ocean Engineering, Institute of Mechanics, Chinese Academy of Sciences.
Beijing, China

ABSTRACT

In suppressing vortex-induced vibration (VIV) of flexible risers in deep sea, a new device based on the Bernoulli equation and effects of geometric disturbance on flows around a bluff body is proposed. The mechanism is the disturbance in a radial-spanwise plane on fluid flows around the body and spanwise uniformity of vortex shedding. In present experiments, two types of disturbance, harmony and cone-like, and different waviness (ratio of wave height to wavelength) of 0.025, 0.05 and 0.1 are investigated. Experimental results have shown that oscillating amplitudes with such disturbance are reduced at mild and high waviness at occurrence of synchronization of a circular cylinder without disturbance. Reduction of RMS values reach up to 48.5% for harmonic disturbance and 53% for cone-like disturbance at the waviness of 0.1.

KEY WORDS: Vortex-induced vibrations; suppression; experiment; wavy disturbance; circular cylinder; passive control; riser.

INTRODUCTION

In many engineering, a great deal of bluff structures are applied, such as bridges, buildings, risers and heat exchange tubes. Such bluff body is usually subjected to a fluid flow at sufficiently higher Reynolds numbers. The flow separates from bluff body giving rise to vortex shedding periodically from either sides of body. This alternating vortex shedding is accompanied with the occurrence of fluctuating pressure forces on structural surfaces. Therefore, the body undergoes vibrations if it is light and flexibly mounted, called vortex-induced vibrations (VIV). These vibrations could be some times large enough to cause structural fatigue damage, even catastrophe, which in turn endangers manufacture and people's living safety. In half a century, many control methods and devices have been proposed and applied, such as radial fins, strake, fairing and control rods. More details can be referenced in reviews by Sarpkaya and Isaacson (1981), and Kumar-Sohn and Gowda (2008).

Generally, all control methods can be classified as two kinds, active and passive control, from the point of view of control theory. However, due to the additional energy consumption frequently in active control, main focus here is put on passive control, especially for flexible risers in deep water in ocean engineering.

VIV is a typical phenomenon arising out of fluid-structure interaction. From points of physical mechanism in generating the acceleration or deceleration of body, two classes of methods are commonly identified, that is, mechanical and fluid dynamical means.

In mechanical methods, the oscillations of risers can be reduced by

increasing structural mass, damping, stiffness and top tension. For example, a Stockbridge damper invented by Dulhunty (2004) is applied in power lines. However, as for pre-designed pipelines in subsea production system, these mechanical methods are not always technically, practically and economically possible. Fluid dynamical methods are thus naturally considered.

Fluid dynamically, VIV suppressions can be realized by introducing disturbances on flows around body interacting with the mechanism of forming and shedding vortex. Based on positions of installed disturbances, four types are classified as disturbances on the incoming flow, flow around the body, wake and the spanwise uniformity of vortex shedding. Typically for disturbances on the inflow, a small control rod installed upstream can reduce the pressure at front stagnation point, then the drag is reduced (Sang and Cheol, 2004). In disturbances on flow around the bluff body, there are many control ways. Three-dimensional geometric disturbance, such as wavy square-section cylinder (Lin-Ling and Wu, 2010), wavy front surface of rectangular cylinder (Bearman and Owen, 1998), interferes in and weakens regular vortex shedding. Then the flow becomes nearly stable. Correspondingly, drag and lift forces are also reduced. Later, a spiraling arrangement of surface control bumps was proposed by Owen-Bearman and Szweczyk (2001). Drag reduction can be reached up to 47% and the regular vortex shedding is also no longer be detected above certain waviness, defined as the ratio of the peak-to-peak wavy height to the wavelength. Control rods with equal space around cylinder investigated by Song *et al.* (2009) are found to be able to reduce the transverse response of risers effectively. Streamline fairing (Lee and Allen, 2005) exhibits very good aerodynamic performance due to the streamlined shape delaying the flow separation. The disturbance of rotatable splitter plates (Assi-Bearman and Kitney, 2009) successfully achieves the delay of interactions between upper and lower free shear layers, as well as the formation of shedding vortex. In methods of disturbance on wake of bluff body, a small splitter plate or rod (Ozono, 2003) is commonly applied as a physical isolation of vortex already shed from shear layers. As for disturbance on spanwise uniformity of vortex shedding, strake (Trim *et al.*, 2005; Korkischko and Meneghini, 2010) or anything else similar to it, such as helical fins or wire ropes, is typical and widely used.

Although it is impossible to compare the advantages and disadvantages of these various devices, limitations of these application can be pointed out for special concerns, that is flexible risers in deep sea presently. For example, disturbances on upstream inflow or wake will be invalid when the flow direction is varied with angle of attack of 90 degree, which is called as the sensitivity of flow direction. Geometric disturbance has also similar trouble because of the wavy shape in streamwise-spanwise plane. The design and installation of surface control bumps is difficult. And it is

only effective at a mass-damping parameter greater than 0.5, which is so high that it does not be appropriate for most subsea risers as we know now. In application of control rods around the risers, a new problem of cleaning attachment of marine organism arises. Rotatable fairing and splitter plates lead to the introduction of dynamic instability of flexible risers. And initial costs are high for fairing. Strakes will increase drag. For some kinds of strakes, the installation is complex. Consequently, a new type of VIV suppression device is needed. From above statement, such device can be investigated from disturbances of flow around body and the spanwise uniformity of vortex shedding as a passive control method.

In present paper, the purpose is mainly put on the design of a new device applied in flexible risers in deep sea and qualitative analysis of its effectiveness in suppressing VIV by experiments. Firstly, the principle of VIV suppression of a new device is illuminated. Then, experiments of a circular cylinder with such device are carried out. Only transverse displacements of test cylinders are measured. Relative analysis and comparison are presented. Finally, the conclusion is given.

PRINCIPLE OF A NEW SUPPRESSION DEVICE

It is common knowledge that the fluid load on the structure consists of two components. One is the differential pressure force, such as the form drag. The other is the viscous shear force. The reduction of fluid force could be realized by decreasing the differential pressure, typically by means of the increasing base pressure. Moreover, the component of differential pressure force is dominant at higher Reynolds numbers.

On the other hand, the Bernoulli equation with assumptions of the ideal, incompressible and barotropic fluid and potential mass force is given by

$$\frac{U^2}{2} + gz + \frac{p}{\rho_f} = C(\psi) \quad (1)$$

where U is the local velocity, g is the acceleration of gravity, z is the spanwise position, and $C(\psi)$ is the integral constant along the different streamlines. If the gravity is ignored, the increasing velocity, as well as the kinetic energy, is accompanied with the decreasing pressure energy. Furthermore, in the theory of Prandtl's boundary layer, the pressure could be nearly invariable along the normal direction of flat plate surface in the boundary layer under the condition of approximation with the magnitude of first order. Similarly, the pressure on the cylinder would be obviously decreased if the pressure is reduced in the boundary layer of the circular cylinder.

Hence, it is indicated by above analysis that the fluid load could be weakened by increasing the local velocity of fluid enveloping the structure.

In an investigation of effects of geometric disturbance on flows around a square-section cylinder at the Reynolds number of 100 and the waviness of 0.025 (Lin, 2007), the pressure on surfaces are reduced, especially on the back surface and points of inflection, as shown in Fig.1. The physical mechanism explained for it is that the wavy disturbance can induce the flow along the wavy spanwise surface. The spanwise component of fluid velocity with specific distribution, which is evidently different from that caused by the three-dimensional instability or turbulence, is appeared and grown up to the greatest near the inflexion. Meanwhile, streamwise and vertical components of vorticity are also induced on surfaces of cylinder. Then, the kinetic energy at the local position is increased at the local position. Therefore, the pressure coefficient on the front stagnation points is reduced from 1.0 down to 0.7~0.9, and the base pressure coefficient is from -0.67 up to -0.4~-0.55. The drag is dropped. The interaction between upper and lower spanwise vortex is delayed down to the far wake and weakened by the vertical vorticity developed from that on cylinder surfaces. The

feature of alternating shedding is almost disappeared in the near wake. Correspondingly, the alternated lift force is reduced down to zero.

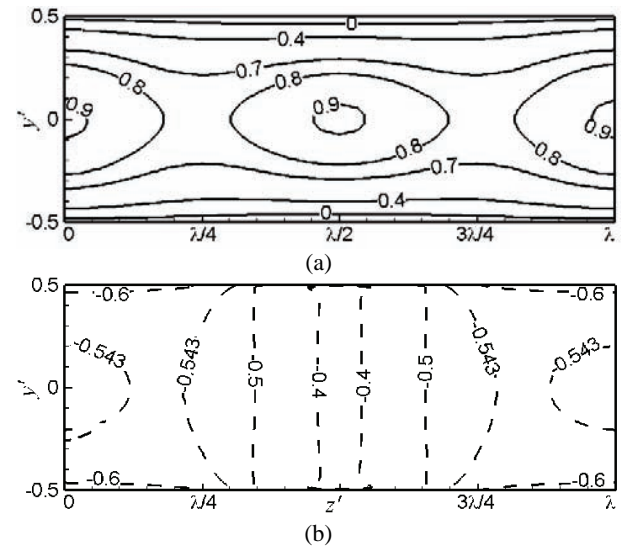

Figure 1. Distribution of pressure coefficients on wavy square-section cylinder surfaces, (a) the front surface, (b) the back surface.

Therefore, a new kind of passive control in suppressing VIV is proposed for flexible risers in deep sea. The outer shape, as well as the outer diameter of whole structure, is varied wavy and periodically along the span of body. And sections of such shape are always circular. It can be defined as the wavy disturbance in a radial-spanwise plane, rather than a streamwise-spanwise plane used previously. Some typical wavy disturbances are designed as harmony, sphere, ellipsoid, cone and cone-like, as shown in Fig.2, called the "bean-pod"-type shroud. It is installed by buckling two halves of such shroud according to the local distribution of ocean current at certain depth with different waviness. The main control parameters of design are the wavelength, the wave height and the waviness when the wavy shape is decided.

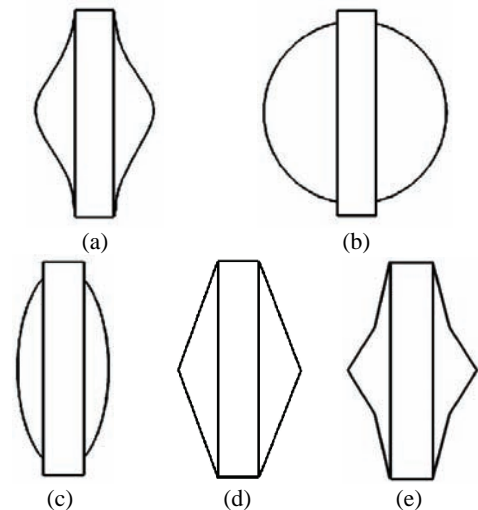

Figure 2. Typical patterns of "bean-pod"-type suppression shroud, (a) harmonic, (b) spherical, (c) ellipsoidal, (d) conical, (e) cone-like.

EXPERIMENTAL DETAILS

The experiments were conducted in a circulating water channel at the Key Laboratory for Hydrodynamics and Ocean Engineering, Institute

of Mechanics, Chinese Academy of Sciences. The test section was 6 m long, 1 m wide. In these tests, the water depth was ranged from 0.65 to 0.7 m. The flow was bi-directionally driven by an electronic motor. The maximum speed could be reached up to 1 m/s.

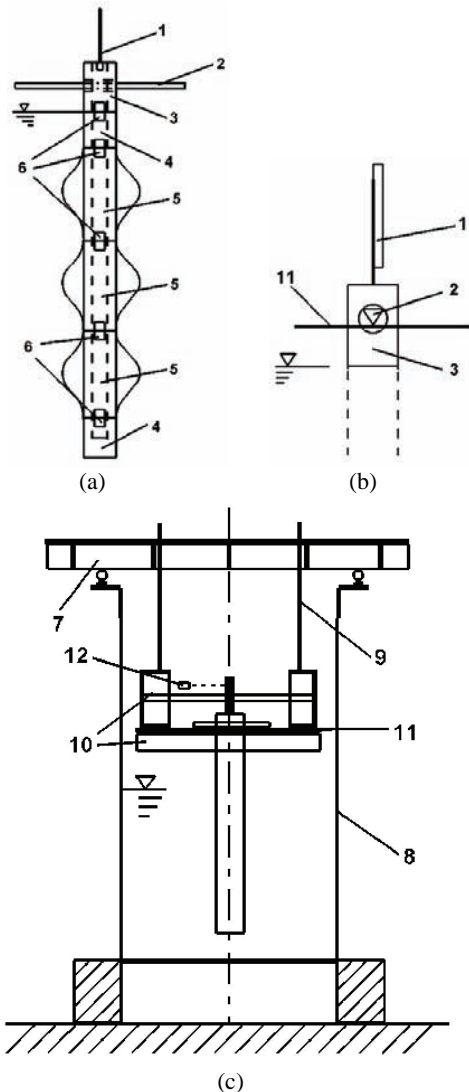

Figure 3. Schematic diagrams of VIV experiments, (a) front view of whole oscillating cylinder in tests, (b) side view of support, (c) experimental platform mounted above the channel, where 1 is the indicating arm, 2 is the equilateral triangle support, 3 and 4 are straight cylinders over and under water respectively, 5 are three segments of straight or wavy cylinder for tests, 6 is the inner screw, 7 is the crossbeam supported on rails, 8 is the channel, 9 is the long screw, 10 and 11 are frames of settling chamber above water, 12 is the laser displacement sensor. It should be noticed that the direction of support in (c) is perpendicular to the inflow direction just for convenience of demonstration, actually parallel to the inflow direction in transverse VIV experiments.

Schematic diagrams of VIV experiments were shown in Fig.3. The whole oscillating structure was mainly composed of overwater and underwater parts, and test cylinders. The overwater part included the indicating arm used to receive the laser beam launched by the laser displacement sensor, the equilateral triangle iron support installed with one apex as the point of support and a straight cylinder with the length of 100 mm. The equilateral triangle support installed as shown in

Fig.3(b) is rotatable due to its sharp edge touched with the platform. The cylinder fixed with such support will be oscillated along a direction perpendicular to the direction of support, which is parallel to the flow direction in tests. The restoration comes from the gravity of whole oscillating cylinder. For the underwater part, two auxiliary cylinders, same as one used in the overwater part, were designed in avoiding effects of wave, free surface and bottom of channel at high incoming velocity. Test cylinders with straight or wavy shapes were manufactured as three parts connected by the inner screw. Each part was 120 mm long. The immersed length of whole structure was 560 mm. All these cylinders were made up of aluminum with same outer diameter of 20 mm and inner diameter of 10 mm. Here, three different waviness for wavy test cylinders, 0.025, 0.05 and 0.1, were studied with the prescribed wavelength of 120 mm. The maximum outer diameters were consequently obtained as 26, 32 and 44 mm, respectively.

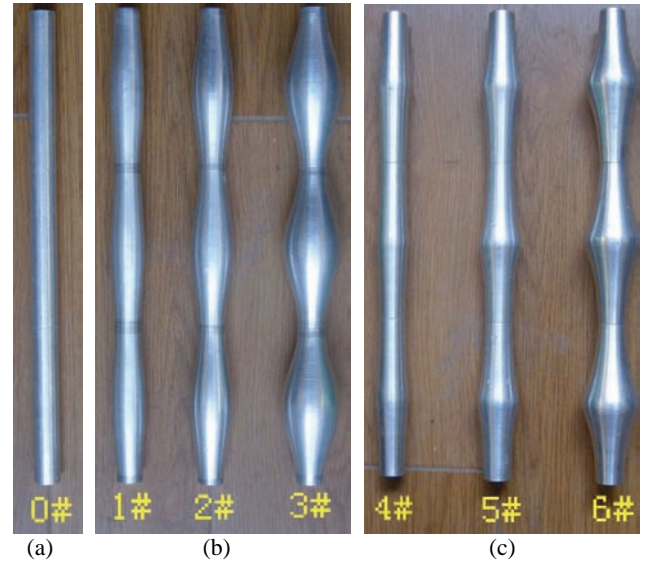

Figure 4. (a) Straight, (b) harmonic, and (c) cone-like cylinder in tests.

Presently, two types of wavy shape, harmony and cone-like, were considered as shown in Fig.4. Among them, 0[#] was the straight cylinder, 1[#], 2[#] and 3[#] were harmonic cylinders with increasing waviness, so 4[#], 5[#] and 6[#] were cone-like cylinders. The mass of those cylinders was listed in Table.1. The mass ratio of whole oscillating structure, non-dimensionalized by the mass of straight cylinder immersed in water, was kept lower in a range from 7 to 10.

Table 1. Mass and mass ratio of cylinders in experiments.

Number of cylinder	Mass* (g) (growth rate)	Mass** (g) (growth rate)	Mass ratio
0	282 (0%)	1246.35 (0%)	7.08
1	382.1 (35.5%)	1346.45 (8%)	7.65
2	512.5 (81.7%)	1476.85 (18.5%)	8.39
3	817.75 (190%)	1780.1 (42.8%)	10.11
4	343.6 (21.8%)	1307.95 (4.9%)	7.43
5	434.2 (54%)	1398.55 (12.2%)	7.95
6	681.6 (141.7%)	1645.95 (32.1%)	9.35

* Only for test cylinders.

** Whole oscillating structure including overwater and underwater parts.

The uniform velocity of incoming flow was measured by the Ultrasonic Doppler speed measuring instrument. The probe was located about 5 m far away from test cylinders.

RESULTS AND ANALYSIS

Damping Estimation

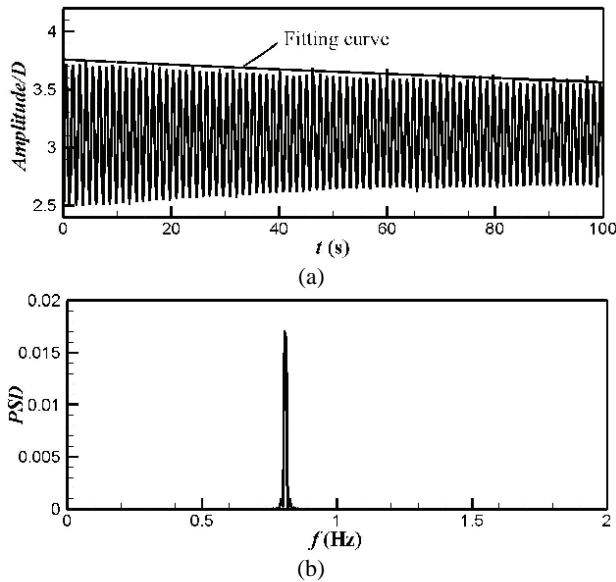

Figure 5. Experiments for free oscillation of the straight cylinder in still air, (a) displacement time history, (b) power spectral density (PSD) of lateral displacement.

In studying response and suppression of VIV, structural damping is also as important as mass ratio. Many suppressors may be effective for high-damping systems but completely useless when damping levels are decreased, especially for risers in deep water. Then free oscillating experiments in still air were carried out in estimating the damping level. As shown in Fig.5, the oscillation of straight cylinder does decay slowly with the natural frequency of 0.81 Hz. Similar phenomenon is also appeared in free oscillations of wavy cylinders with different waviness. The fitting curve, in Fig.5(a), deviated parallel from the actual curve for display clearly, is obtained based on the following equation,

$$y(t) = y_0 + ae^{-\xi 2\pi f_{n0} t}$$

(2)

where $y(t)$ is the time history of displacement, y_0 is the averaged value indicating oscillating central position, a is a parameter of 0.653, ξ is the dimensionless damping coefficient of 7×10^{-4} of oscillating system, and f_{n0} is the natural frequency of structure.

It is verified that the damping level is surely very little quantitatively. Systematic damping consists of structural and fluid damping. Therefore, the structural damping, only related to the friction between support and flat platform, would be less or equal to such level.

Natural Frequency of Oscillating Structures in Still Water

Before experiments of VIV, the natural frequency of oscillating structures was measured through the free vibration in still water. The time histories of transverse displacements for straight and wavy cylinders were recorded, typically as shown in Fig.6. Although there are many disturbed signals with large amplitudes, the natural frequency

can be still identified clearly.

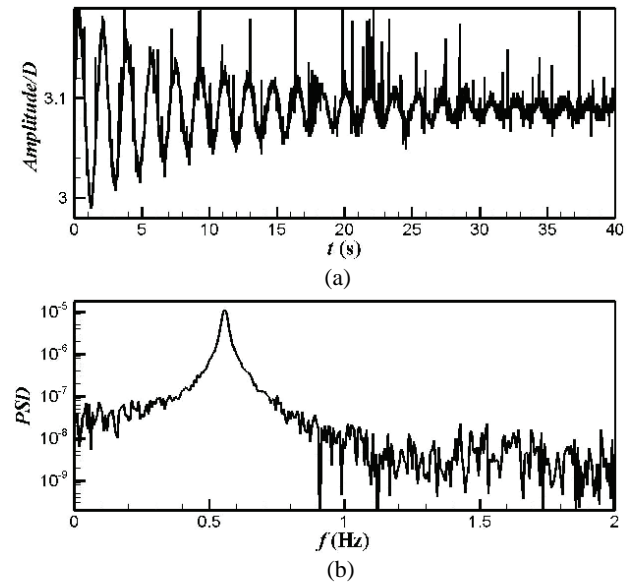

Figure 6. Experiments for free oscillation of the straight cylinder in still water, (a) displacement time history, (b) PSD of lateral displacement.

Hence, natural frequencies of oscillating structures are obtained, as listed in Table.2. As for two wavy types, their natural frequencies are almost same to that of straight cylinder. At least in present experiments, noticeable changes in frequency does not occurred when the waviness is increasing and the outer shape of structure is varied.

Table 2. Natural frequencies of straight and wavy structures oscillating freely in still water.

Number of cylinder		Natural frequency (Hz)
Straight	0	0.56
Harmonic	1	0.56
	2	0.56
	3	0.56
Cone-like	4	0.55
	5	0.55
	6	0.55

Table 3. Re, St and estimated frequency of vortex shedding in flows around a still circular cylinder.

Velocity (cm/s)	Re	St	f_{j0} (Hz)
5	1000	0.22	0.55
10	2000	0.21	1.05
15	3000	0.21	1.58
20	4000	0.21	2.1
25	5000	0.21	2.63
30	6000	0.21	3.15
40	8000	0.2~0.21	4~4.2

In addition, the frequency of vortex shedding in flows around the fixed structure is also estimated based on the relationship between the Reynolds number and the Strouhal number. It is well known that the

Strouhal number is nearly 0.2 when the Reynolds number is varied from 10^3 to 10^4 in flows around a circular cylinder. Therefore, vortex-shedding frequency can be estimated if the incoming velocity is given, as listed in Table.3, where the Strouhal number is taken from the book by Sarpkaya and Isaacson (1981). By comparing frequencies of vortex shedding and oscillating structures, it can be predicted that the vortex-induced vibrations would be occurred near the incoming velocity of 5 cm/s. As a result, the test velocity will be 5 cm/s in VIV experiments.

Characteristics of Response for a Straight Cylinder

When the uniform incoming velocity is varied from 5 cm/s to 40 cm/s, the response of oscillating displacement of a straight cylinder is presented as shown in Fig.7. The structure does vibrate on synchronization when the reduced velocity, defined as the incoming velocity non-dimensionalized by the natural frequency of structure, is varied from 4 to 10. With the increasing or decreasing reduced velocity, values of oscillation are not changed obviously.

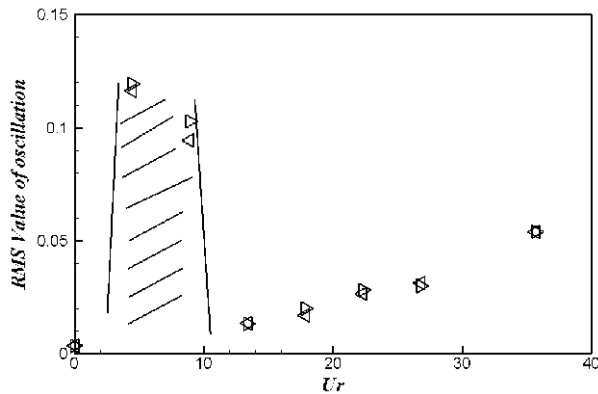

Figure 7. The RMS values of response displacement versus the reduced velocity for the straight cylinder, \triangleright and \triangleleft indicate that the reduced velocity is increasing and decreasing, respectively. The region of shadow denotes the occurrence of synchronization.

Through the frequency analysis as shown in Fig.8 where the incoming velocities are presented typically on and out of synchronization, the structure is oscillated in a single frequency on synchronization, but vibrated weakly in many frequencies out of synchronization. The synchronized frequency at the incoming velocity of 5 cm/s, 0.58 Hz, is a little higher than the natural frequency, 0.56 Hz.

Features of Response for Wavy Cylinders

At the uniform velocity of 5 cm/s, the lateral displacements of oscillation for wavy cylinders are measured. At the minimum of waviness of 0.025, the oscillation is a little stronger than that without wavy disturbance, whatever the wavy type is. Therefore, the results of waviness of 0.05 and 0.1 are presented.

As shown in Fig.9, the vibrating range is certainly reduced in comparison with that for straight cylinder. This can be shown clearly by comparing the RMS values, as shown in Table.4. In present experimental conditions, the reduction of oscillating displacement is obviously, especially for the greatest waviness of 0.1. The maximum reduction can be reached up to 48.5% for harmonic disturbance and 53.1% for cone-like disturbance. It should be considered here the effect of increasing mass on the reduction of oscillating displacement. In Table.1, the grown rate of mass for harmonic cylinder is higher about one third than that for cone-like cylinder at the same waviness, while the reduction is lower or higher near one tenth in Table.4. Hitherto, it

can be concluded reasonably that the cone-like disturbance has a better effect of VIV suppression than the harmonic disturbance due to the greater reduction of oscillation and the smaller mass, qualitatively.

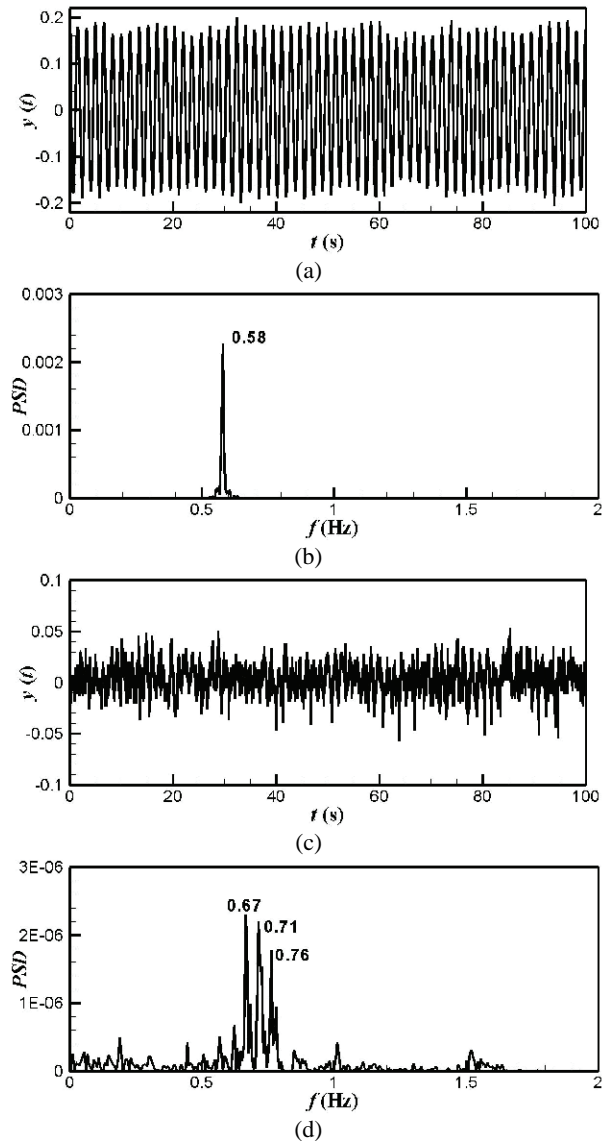

Figure 8. For the straight cylinder, (a) displacement time history and (b) PSD at incoming velocity of 5 cm/s, (c) displacement time history and (d) PSD at incoming velocity of 15 cm/s.

After the frequency analysis, oscillating frequencies for these structures of 0.53, 0.54, 0.52 and 0.53 Hz are all a little smaller than corresponding natural frequencies.

CONCLUSIONS

In present works, a new device in suppressing VIV is proposed based on the Bernoulli equation and effects of wavy geometric disturbance. Such passive-control device is a new kind of wavy disturbance in a radial-spanwise plane, called the “bean-pod”-type shroud for VIV suppression.

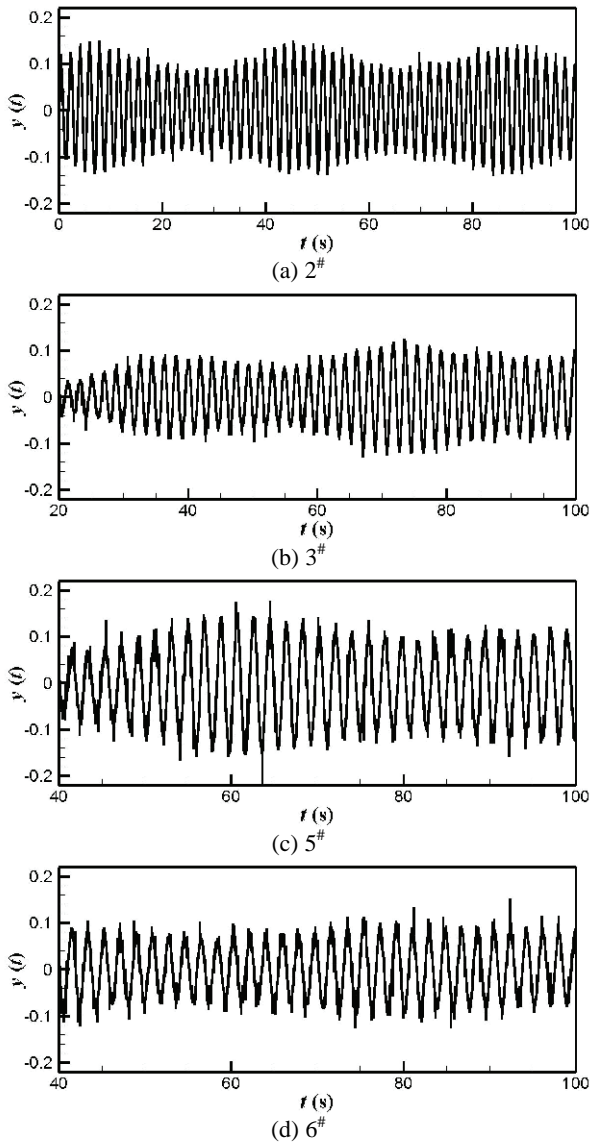

Figure 9. Displacement time histories for wavy cylinders at the uniform velocity of 5 cm/s.

Table 4. RMS values and reduction for test structures at uniform incoming velocity of 5 cm/s.

Number of cylinder	RMS values ($\times 10^3$)	Reduction
0	119.4	0
2	76.9	35.6%
3	61.5	48.5%
5	78.9	33.9%
6	55.9	53.2%

Under present experimental situations, the vibrating amplitude of a straight circular cylinder on synchronization can be reduced by the introduction of this new device. Two types of wavy shape, harmony and cone-like, are investigated. Reductions of RMS value of oscillating displacement at the occurrence of synchronization up to at least 30% at waviness of 0.05 and nearly 50% at waviness of 0.1 are achieved.

ACKNOWLEDGEMENTS

The authors sincerely acknowledge the support of the Knowledge Innovation Program of Chinese Academy of Sciences under Grant No KJCX2-YW-L02, and the Important National Science & Technology Specific Projects of Grant No 2008ZX05056-03-06 for the work reported in this paper.

REFERENCES

- Assi, GRS, Bearman, PW, and Kitney, N (2009). "Low drag solutions for suppressing vortex-induced vibration of circular cylinders," *J Fluids Struct*, Vol 25, pp666-675.
- Bearman, PW, and Owen, JC (1998). "Reduction of bluff-body drag and suppression of vortex shedding by the introduction of wavy separation lines," *J Fluids Struct*, Vol 12, pp123-130.
- Dulhunty, PW (2004): US20040035601A1.
- Korkischko, I, and Meneghini, JR (2010). "Experimental investigation of flow-induced vibration on isolated and tandem circular cylinders fitted with strakes," *J Fluids Struct*, Vol 26, pp611-625.
- Kumar, RA, Sohn, CH, and Gowda, BHL (2008). "Passive control of vortex-induced vibrations: an overview," *Recent Patents on Mechanical Eng*, Vol 1, No 1, pp 1-11.
- Lee, L, and Allen, DW (2005). "The dynamic stability of short fairings," *Offshore Tech Conf Houston, Texas, USA*, OTC 17125.
- Lee, Sang-Joon, Lee, Sang-Ik, and Park, Cheol-Woo (2004). "Reducing the drag on a circular cylinder by upstream installation of a small control rod," *Fluid Dyn Research*, Vol 34, pp233-250.
- Lin, LM, Ling, GC, and Wu, YX (2010). "Mechanism responsible for the complete suppression of Karman vortex in flows past a wavy square-section cylinder," *Chin Phys Lett*, Vol 27, No 3, pp034702.
- Owen, JC, Bearman, PW, and Szewczyk, AA (2001). "Passive control of VIV with drag reduction," *J Fluids Struct*, Vol 15, pp597-605.
- Ozono, S (2003). "Vortex suppression of the cylinder wake by detectors," *J Wind Eng Indust Aerodyn*, Vol 91, pp91-99.
- Sarpkaya, T, and Isaacson, M (1981). *Mechanics of wave forces on offshore structures*. Van Nostrand Reinhold Company, 606pp.
- Song, JN, et al. (2009). "Experimental investigation of suppression of vortex-induced vibration of marine risers by three control rods," *Ocean Eng*, Vol 27, No 3, pp23-29.
- Trim, AD, Braaten, H, Lie, H, and Tognarelli, MA (2005). "Experimental investigation of vortex-induced vibration of long marine risers," *J Fluid Struct*, Vol 21, pp335-361.